

AQUA LAB

Water Activity Meter

Operator's Manual
Version 6



for AquaLab Series 3

Decagon Devices, Inc.

Decagon Devices, Inc.
2365 NE Hopkins Court
Pullman WA 99163
(509) 332-2756
fax: (509) 332-5158
www.decagon.com
support@decagon.com

Trademarks
AquaLab is a registered trademark of
Decagon Devices, Inc.

© 1990-2009 Decagon Devices, Inc.

Contents

1. Introduction	1
About this Manual	1
Customer Support	1
Warranty	2
Seller's Liability	3
2. About AquaLab	4
AquaLab 3 Instrument Specifications	4
AquaLab and Water Activity	5
How AquaLab works	5
AquaLab and Temperature	6
Limitations	8
3. Water Activity Theory	9
Moisture content	9
Water activity	9
Temperature Effects	11
Water Potential	12
Factors in Determining Water Potential	13
Sorption Isotherms	15
4. Getting Started	17
Components of your AquaLab	17
Choosing a Location	17
Features	18
Preparing AquaLab for Operation	19
5. The Menus	21
The Measurement Screen	21

AquaLab

Table of Contents

Changing Languages	21
Normal Sampling Mode	22
Continuous Mode	23
Temperature Equilibration Screen	23
System Configuration	24
6. Cleaning and Maintenance	27
Cleaning the Block and Sensors	28
Cleaning Procedure:	29
Checking Calibration	32
7. Verification and Calibration	33
Water Activity Verification	33
Calibration Standards	33
Calibration	35
8. Sample Preparation	41
Preparing the Sample	41
Samples Needing Special Preparation ..	43
Low Water Activity	46
9. Taking a Reading	48
Measurement Steps	48
How AquaLab takes Readings	49
Cautions	49
10. Computer Interface	52
AquaLink Software	52
Using Windows Hyperterminal	53
11. Troubleshooting	54
Component Performance Screen	62

12. Support and Repair	64
Shipping Directions:	64
Repair Costs	66
Loaner Service	66
13. Further Reading	67
Water Activity Theory & Measurement	67
Food Quality and Safety	71
Water Activity and Microbiology	73
Water Activity in Foods	77
Pharmaceuticals/Cosmetics	86
Miscellaneous	88
Appendix A	90
Preparing Salt Solution	90
Appendix B	92
Declaration of Conformity	93
Certificate of Traceability	94

1. Introduction

Welcome to Decagon's **AquaLab Series 3**, the industry standard for measuring water activity (a_w). AquaLab is the quickest, most accurate, and most reliable instrument available for measuring water activity. Whether you are doing research or working on the production line, AquaLab will suit your needs. It is easy to use and provides accurate and timely results. We hope you find this manual informative and helpful in understanding how to maximize the capabilities of your AquaLab.

About this Manual

Included in this manual are instructions for setting up your AquaLab, verifying the calibration of the instrument, preparing samples, and maintaining and caring for your instrument. Please read these instructions before operating AquaLab to ensure that the instrument performs to its full potential.

Customer Support

If you ever need assistance with your AquaLab, or if you just have questions, there are several ways to contact us:

NOTE: If you purchased your AquaLab through a distributor, please contact them for assistance.

AquaLab

1. Introduction

E-mail

support@decagon.com

Please include your name, contact information, instrument serial number(s), and a description of your problem or question.

sales@decagon.com

Please include your name, address, phone number, the items you wish to order and a purchase order number. Credit card numbers should always be called in.

Phone

1-800-755-2751 (USA and Canada Only)

1-509-332-2756 (International)

Our Customer Support and Sales Representatives are available Monday thru Friday.

Fax

1-509-332-5158

Warranty

AquaLab has a 30-day satisfaction guarantee and a three-year warranty on parts and labor. Your warranty is automatically validated upon receipt of the instrument. We will contact you within the first 90 days of your purchase to see how the AquaLab is working for you.

Seller's Liability

Seller warrants new equipment of its own manufacture against defective workmanship and materials for a period of three years from date of receipt of equipment (the results of ordinary wear and tear, neglect, misuse, accident and excessive deterioration due to corrosion from any cause are not to be considered a defect); but Seller's liability for defective parts shall in no event exceed the furnishing of replacement parts Freight on Board the factory where originally manufactured. Material and equipment covered hereby which is not manufactured by Seller shall be covered only by the warranty of its manufacturer. Seller shall not be liable to Buyer for loss, damage or injuries to persons (including death), or to property or things of whatsoever kind (including, but not without limitation, loss of anticipated profits), occasioned by or arising out of the installation, operation, use, misuse, nonuse, repair, or replacement of said material and equipment, or out of the use of any method or process for which the same may be employed. The use of this equipment constitutes Buyer's acceptance of the terms set forth in this warranty. There are no understandings, representations, or warranties of any kind, express, implied, statutory or otherwise (including, but without limitation, the implied warranties of merchantability and fitness for a particular purpose), not expressly set forth herein.

2. About AquaLab

AquaLab is the quickest and most accurate instrument available for measuring water activity, giving readings in five minutes or less. Its readings are the most reliable providing $\pm 0.003a_w$ accuracy. The instrument is easy to clean and checking calibration is simple.

AquaLab 3 Instrument Specifications

Water Activity Range: 0.030 to 1.000

Water Activity Accuracy: ± 0.003

Water Activity Resolution: ± 0.001

Read time¹: < 5 min.

Sample Temperature Range: 15 to 50° C

Sample Temperature accuracy²: $\pm 0.2^\circ$ C

Sample Temperature resolution: 0.1° C

Sample Dish Capacity: 7 ml recommended (15 ml full)

Operating Environment: 4 to 50° C;

0 to 90% Relative Humidity (non-condensing)

Case Dimensions: 24.1 x 22.9 x 8.9 cm

Weight: 3.2 Kg

Case Material: Powder Painted Aluminum

Display: 20 x 2 alphanumeric LCD with backlighting

Data Communication: RS232A compatible, 8-data bit

ASCII code, 9600 baud, no parity, 1 stop bit

Power: 110VAC to 220 VAC, 50/60 Hz

Warranty: 3 year parts and labor

¹on samples with no significant impedance to vapor loss

²AquaLab is calibrated to a NIST traceable temperature standard.

AquaLab and Water Activity

Water activity (a_w) is a measurement of the energy status of the water in a system. It indicates how tightly water is “bound”, structurally or chemically, within a substance. Water activity is the relative humidity of air in equilibrium with a sample in a sealed measurement chamber. The concept of water activity is of particular importance in determining product quality and safety. Water activity influences color, odor, flavor, texture and shelf-life of many products. It predicts safety and stability with respect to microbial growth, chemical and biochemical reaction rates, and physical properties. For a more detailed description of water activity as it pertains to products, please refer to Chpt. 3 of this manual, titled “Water Activity Theory”.

How AquaLab works

AquaLab uses the chilled-mirror dew point technique to measure the water activity of a sample. In an instrument that uses the dewpoint technique, the sample is equilibrated with the headspace of a sealed chamber that contains a mirror and a means of detecting condensation on the mirror. At equilibrium, the relative humidity of the air in the chamber is the same as the water activity of the sample. In the AquaLab, the mirror temperature is pre-

AquaLab

2. About AquaLab

cisely controlled by a thermoelectric (Peltier) cooler. Detection of the exact point at which condensation first appears on the mirror is observed with a photoelectric cell. A beam of light is directed onto the mirror and reflected into a photodetector cell. The photodetector senses the change in reflectance when condensation occurs on the mirror. A thermocouple attached to the mirror then records the temperature at which condensation occurs. AquaLab then signals you by flashing a green LED and/or beeping. The final water activity and temperature of the sample is then displayed.

In addition to the technique described above, AquaLab uses an internal fan that circulates the air within the sample chamber to reduce equilibrium time. Since both dew-point and sample surface temperatures are simultaneously measured, the need for complete thermal equilibrium is eliminated, which reduces measurement times to less than five minutes.

AquaLab and Temperature

The AquaLab Series 3 does not control temperature, making it ideal for the measurement of samples at room temperature. However, samples that are not at room temperature during the read cycle will equilibrate to the temperature of AquaLab before the water activity is displayed. Large temperature differences will cause longer reading times, since a complete and accurate reading will not be made until the sample and the instrument are within 2 degrees of each other. To better help you control

the temperature difference between your sample and the instrument, you can access a sample equilibration screen at the main menu that can shows the difference in temperature between the sample and chamber block (see chpt. 4).

If temperature control is desired, Decagon offers a temperature-controlled model, the AquaLab 4TE. There are several advantages in having a temperature-controlled model. Here are a few major reasons:

1. **Research purposes.** To study the effects of temperature on the water activity of a sample, comparison of the water activity of different samples independent of temperature, accelerated shelf-life studies or other water activity studies where temperature control is critical. There are many shelf-life, packaging, and isotherm studies in which the added feature of temperature control would be very beneficial.
2. **To comply with government or internal regulations** for specific products. Though the water activity of most products varies by less than ± 0.002 per $^{\circ}\text{C}$, some regulations require measurement at a specific temperature. The most common specification is 25°C , though 20°C is sometimes indicated.
3. **To minimize extreme ambient temperature fluctuations.** If the environment that the AquaLab operates in has temperatures that fluctuate by as much as \pm

AquaLab

2. About AquaLab

5°C daily, water activity readings will vary by $\pm 0.01a_w$. Such variations in ambient temperatures are uncommon. As stated above, this much uncertainty in sample water activity is sometimes acceptable, so there may be no need for temperature control. However, if your lab temperature varies to this degree and you require better than $0.01a_w$ precision, you may want a temperature-controlled model.

If your application meets any of the criteria listed above, you may want to use the AquaLab 4TE.

Limitations

AquaLab's only major limitation is its ability to accurately measure samples with high concentrations of certain volatiles such as ethanol or propylene glycol, which can co-condense on the surface of the chilled mirror. Not all volatiles react this way, but it is important to note that some volatiles can affect the performance of your instrument. The extent of the effect is both concentration- and matrix-dependent; thus, just because a product contains some ethanol or propylene glycol does not necessarily mean the readings will be erroneous. Therefore, if your sample contains propylene glycol or a high concentration of other volatiles, it is still possible to make accurate readings. Refer to the section titled "Volatile Samples" in Chapter 8 or contact Decagon for more details.

3. Water Activity Theory

Water is a major component of foods, pharmaceuticals, and cosmetics. Water influences the texture, appearance, taste and spoilage of these products. There are two basic types of water analysis: water content and water activity.

Moisture content

The meaning of the term moisture content is familiar to most people. It implies a quantitative analysis to determine the total amount of water present in a sample. Primary methods for determining moisture content are loss on drying and Karlf Fisher titration, but secondary methods such as infrared and NMR are also used. Moisture content determination is essential in meeting product nutritional labeling regulations, specifying recipes and monitoring processes. However, moisture content alone is not a reliable indicator for predicting microbial responses and chemical reactions in materials. The limitations of moisture content measurement are attributed to differences in the intensity with which water associates with other components.

Water activity

Water activity is a measure of the energy status of the

AquaLab

3. Water Activity Theory

water in a system, and thus is a far better indicator of perishability than water content. *Figure 1* shows how the relative activity of microorganisms, lipids and enzymes relate to water activity. While other factors, such as nutrient availability and temperature, can affect the relationships, water activity is the best single measure of how water affects these processes.

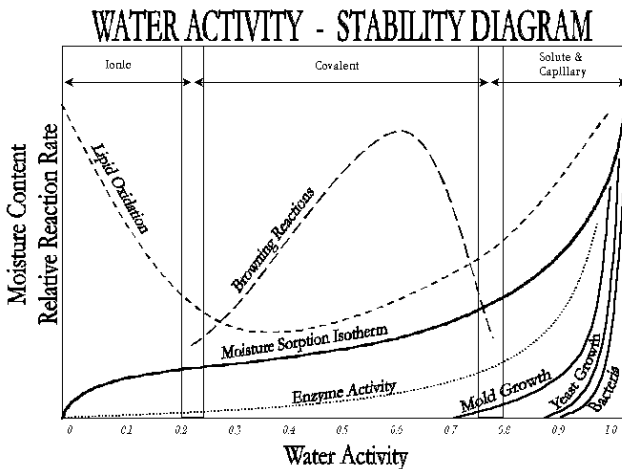

Fig. 1: Water Activity Diagram—adapted from Labuza

Water activity of a system is measured by equilibrating the liquid phase water in the sample with the vapor phase water in the headspace and measuring the relative humidity of the headspace. In the AquaLab, a sample is placed in a sample cup which is sealed against a sensor block. Inside the sensor block is a fan, a dew point sensor, a temperature sensor, and an infrared thermometer. The dew point sensor measures the dew point temperature of the air, and

the infrared thermometer measures the sample temperature. From these measurements the relative humidity of the headspace is computed as the ratio of dew point temperature saturation vapor pressure to saturation vapor pressure at the sample temperature. When the water activity of the sample and the relative humidity of the air are in equilibrium, the measurement of the headspace humidity gives the water activity of the sample. The purpose of the fan is to speed equilibrium and to control the boundary layer conductance of the dew point sensor.

In addition to equilibrium between the liquid phase water in the sample and the vapor phase, the internal equilibrium of the sample is important. If a system is not at internal equilibrium, one might measure a steady vapor pressure (over the period of measurement) which is not the true water activity of the system. An example of this might be a baked good or a multi-component food. Initially out of the oven, a baked good is not at internal equilibrium; the outer surface is at a lower water activity than the center of the baked good. One must wait a period of time in order for the water to migrate and the system to come to internal equilibrium. It is important to remember the restriction of the definition of water activity to equilibrium.

Temperature Effects

Temperature plays a critical role in water activity determinations. Most critical is the measurement of the difference between sample and dew point temperature. If this tem-

AquaLab

3. Water Activity Theory

perature difference were in error by 1°C , an error of up to $0.06a_w$ could result. In order for water activity measurements to be accurate to 0.001, temperature difference measurements need to be accurate to 0.017°C . AquaLab's infrared thermometer measures the difference in temperature between the sample and the block. It is carefully calibrated to minimize temperature errors, but achieving 0.017°C accuracy is difficult when temperature differences are large. Best accuracy is therefore obtained when the sample is near chamber temperature.

Another effect of temperature on water activity occurs with samples are near saturation. A sample that is close to $1.0a_w$ and is only slightly warmer than the sensor block will condense water within the block. This will cause errors in the measurement, and in subsequent measurements until the condensation disappears. A sample at $0.75a_w$ needs to be approximately 4°C above the chamber temperature to cause condensation. The AquaLab warns the user if a sample is more than 4°C above the chamber temperature, but for high water activity samples the operator needs to be aware that condensation can occur if a sample that is warmer than the block is put in the AquaLab.

Water Potential

Some additional information may be useful for understanding what water activity is and why it is such a useful measure of moisture status in products. Water activity is

closely related to a thermodynamic property called the water potential, or chemical potential (m) of water, which is the change in Gibbs free energy (G) when water concentration changes. Equilibrium occurs in a system when m is the same everywhere in the system. Equilibrium between the liquid and the vapor phases implies that m is the same in both phases. It is this fact that allows us to measure the water potential of the vapor phase and use that to determine the water potential of the liquid phase. Gradients in m are driving forces for moisture movement. Thus, in an isothermal system, water tends to move from regions of high water potential (high water activity) to regions of low water potential (low water activity). Water content is not a driving force for water movement, and therefore can not be used to predict the direction of water movement, except in homogeneous materials.

Factors in Determining Water Potential

The water potential of the water in a system is influenced by factors that effect the binding of water. They include osmotic, matric, and pressure effects. Typically water activity is measured at atmospheric pressure, so only the osmotic and matric effects are important.

Osmotic Effects

Osmotic effects are well known from biology and physical chemistry. Water is diluted when a solute is added. If this diluted water is separated from pure water by a semi-per-

AquaLab

3. Water Activity Theory

meable membrane, water tends to move from the pure water side through the membrane to the side with the added solute. If sufficient pressure is applied to the solute-water mixture to just stop the flow, this pressure is a measure of the osmotic potential of the solution. Addition of one mole of an ideal solute to a kilogram of water produces an osmotic pressure of 22.4 atm. This lowers the water activity of the solution from 1.0 to $0.98a_w$. For a given amount of solute, increasing the water content of the systems dilutes the solute, decreasing the osmotic pressure, and increasing the water activity. Since microbial cells are high concentrations of solute surrounded by semi-permeable membranes, the osmotic effect on the free energy of the water is important for determining microbial water relations and therefore their activity.

Matric Effects

The sample matrix affects water activity by physically binding water within its structure through adhesive and cohesive forces that hold water in pores and capillaries, and to particle surfaces. If cellulose or protein were added to water, the energy status of the water would be reduced. Work would need to be done to extract the water from this matrix. This reduction in energy status of the water is not osmotic, because the cellulose or protein concentrations are far too low to produce any significant dilution of water. The reduction in energy is the result of direct physical binding of water to the cellulose or protein matrix by hydrogen bonding and van der Waal forces. At higher

water activity levels, capillary forces and surface tension can also play a role.

Sorption Isotherms

Relating Water Activity to Water Content

Changes in water content affect both the osmotic and matric binding of water in a product. Thus a relationship exists between the water activity and water content of a product. This relationship is called the sorption isotherm, and is unique for each product. Besides being unique to each product, the isotherm changes depending on whether it was obtained by drying or wetting the sample. These factors need to be kept in mind if one tries to use water content to infer the stability or safety of a product. Typically, large safety margins are built in to water content specifications to allow for these uncertainties.

While the sorption isotherm is often used to infer water activity from water content, one could easily go the other direction and use the water activity to infer the water content. This is particularly attractive because water activity is much more quickly measured than water content. This method gives particularly good precision in the center of the isotherm. In order to infer water content from water activity, one needs an isotherm for the particular product; produced, ideally, using the process that brings the product to its final water content.

AquaLab

3. Water Activity Theory

For example, if one were using the AquaLab to monitor the water content of dried potato flakes, one would measure the water activity and water content of potato flakes dried to varying degrees using the standard drying process for those flakes. An isotherm would be constructed using those data, and the water content would be inferred using the measured water activity of samples and that isotherm.

The importance of the concept of water activity of foods, pharmaceuticals, and cosmetics cannot be overly emphasized. Water activity is a measure of the energy status of the water in a system. More importantly, the usefulness of water activity in relation to microbial growth, chemical reactivity, and stability over water content has been shown.

4. Getting Started

Components of your AquaLab

Your AquaLab should have been shipped with the following items:

- AquaLab water activity meter
- Power cord
- RS-232 interface cable
- 100 disposable sample cups
- Operator's Manual
- Quick Start guide
- Cleaning Kit
- 3 vials each of the following calibration solutions:
 - 1.000_{a_w} Distilled Water
 - 0.760_{a_w} 6.0 molal NaCl
 - 0.500_{a_w} 8.57 molal LiCl
 - 0.250_{a_w} 13.41 molal LiCl

Choosing a Location

To ensure that your AquaLab operates correctly and consistently, place it on a level surface. This reduces the chance that sample material will spill and contaminate the sample chamber. Also select a location where the temperature remains fairly stable to avoid temperature changes that can affect accuracy. This location should be well away from air

AquaLab

4. Getting Started

conditioner and heater vents, open windows, etc. Place the AquaLab in a location where cleanliness can be maintained to prevent contamination of the sample chamber.

Features

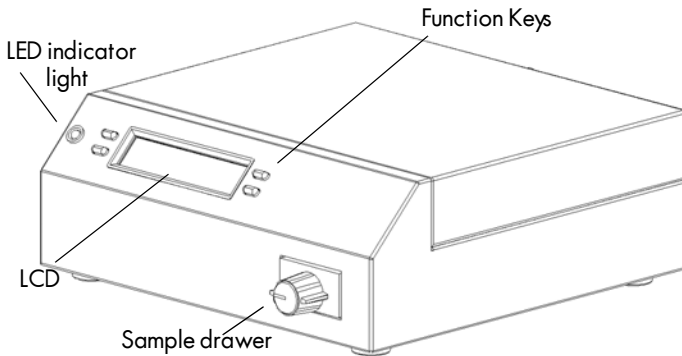

Front view of AquaLab

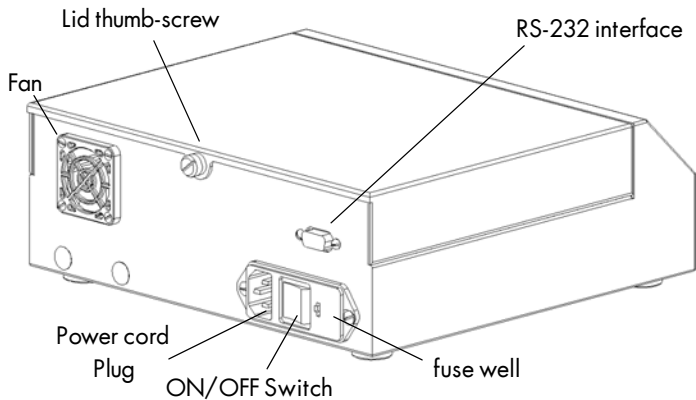

Back view of AquaLab

Preparing AquaLab for Operation

After finding a good location for your AquaLab, plug the power cord into the back of the unit. Before turning it on, turn the knob to the “OPEN/LOAD” position, pull open the sample drawer and remove the empty disposable sample cup. This empty cup is placed in the drawer to protect it during shipment. Turn the instrument on (see features diagram). The following screens will appear on the LCD.



AQUALAB
Series 3B v 3.0

(Note: the “v.3.0” shown in the above illustration is an example showing the version of operating code used in the instrument. We periodically update the code and add new features, so if your AquaLab shows a version number higher than this, don’t be alarmed.)

Then the screen will automatically shift to the measurement screen shown below:



0.000 a_w 0.0 °C

This is the measurement screen, displaying the water activity (a_w) on the top left portion of the screen, and the sample temperature in the lower right.

AquaLab

4. Getting Started

In order to provide the most accurate readings, your AquaLab should ideally be allowed to warm-up for at least 15 minutes after turning it on. This allows the air inside the AquaLab to equilibrate to the temperature of its surroundings.

5. The Menus

The Measurement Screen



Each time you turn on your AquaLab, the screen above will appear. As mentioned earlier, the water activity and sample temperature are displayed on the screen. On each side of the LCD there are two buttons. Each button performs a different function. Following is a description of the modes and options you may use, and the buttons used to set them.

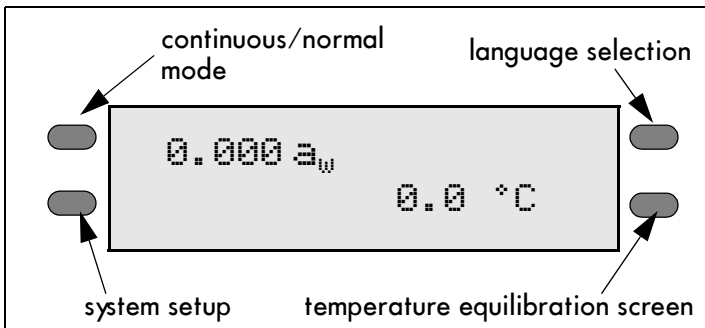

diagram of button options from main menu

Changing Languages

The AquaLab comes to you with English as the default

AquaLab

5. The Menus

on-screen user language. If you prefer not to use English, you can change it to one of a variety of other languages: German, French, Spanish, Italian, Swedish, Danish, Norwegian, Czech, Portuguese, Japanese, Polish or Finnish. This is done simply by pressing the upper right button of the instrument while the drawer knob is in the OPEN/LOAD position. You will see the following screen:



A screenshot of a monochrome LCD display. The word "English" is displayed in a pixelated font in the upper right corner. In the lower left corner, the text "-exit-" is displayed, also in a pixelated font.

Press the upper right key again, and the next language option (German) will appear:



A screenshot of a monochrome LCD display. The word "Deutsch" is displayed in a pixelated font in the upper right corner. In the lower left corner, the text "-zurück-" is displayed, also in a pixelated font.

Each time you press the right button, the display will scroll to the next language option. Select the desired language, then press the lower left button to exit.

Normal Sampling Mode

The first time you turn on the AquaLab, it will be in normal sampling mode. In this mode, the sample is measured once, after which the instrument notifies you that it is finished with a series of four beeps and a green flashing light. The operator has the ability to change the sampling mode and the audible alarm.

Continuous Mode

Continuous mode reads your sample continuously until you turn the knob to the OPEN/LOAD position. It will read the sample, display the water activity and sample temperature, then begin another read cycle without turning the knob. Between samples, it will signal you with the green LED flash, accompanied by the beeper (if it is enabled).

To toggle between the normal and continuous modes, press the top left button. The display will show a small “c” to the left of the water activity readings:

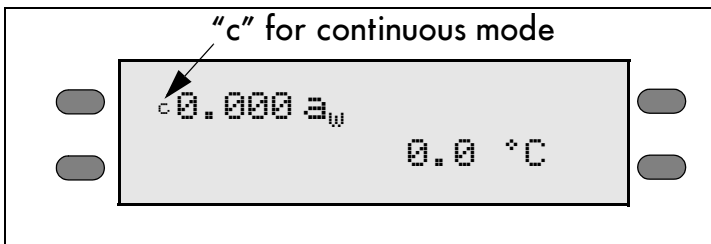

main menu with continuous mode enabled

If you press the upper left button again, the “c” will disappear and you will be back in normal sampling mode.

Temperature Equilibration Screen

To see the temperature difference between your sample and the AquaLab, press the lower right button at the main menu. This screen can only be accessed when the drawer

AquaLab

5. The Menus

knob is in the OPEN/LOAD position. The following screen will appear:

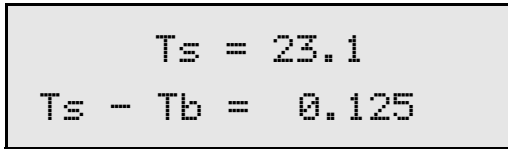

The screenshot shows a rectangular display area with a black border. Inside, the text is displayed in a monospaced font. The first line reads "Ts = 23.1" and the second line reads "Ts - Tb = 0.125".

This screen shows the temperature difference between the sample (T_s) and the chamber block (T_b), allowing you to quickly check if the sample is too hot, which may cause condensation inside the chamber. Press the lower right button to exit.

System Configuration

If you press the bottom left button while at the measurement screen, it will bring you to the system configuration menu.

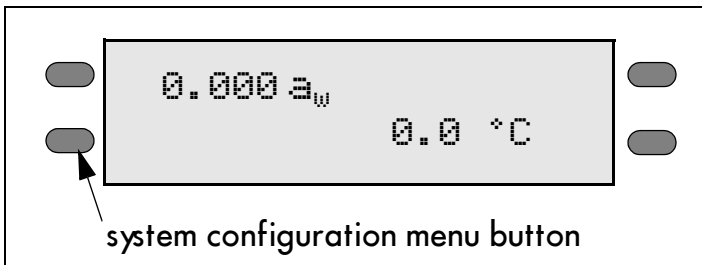

This menu allows you to make minor system changes. From this menu, you can change the audible alarm after each sample or enter the linear offset adjustment menu.

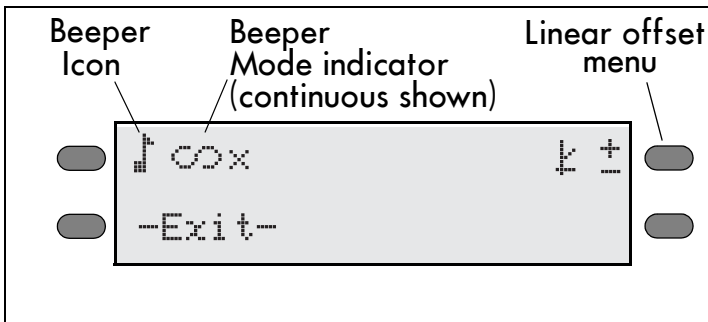

System configuration menu

Completion Notification

When you are sampling, the AquaLab has two ways of notifying you that the water activity reading is complete: an audible alarm and a flashing green LED, located on the left front corner of the AquaLab's case. In normal sampling mode, when a sample is started, the LED will flash once, and when it is finished it will flash continuously until the knob is moved to the OPEN/LOAD position (if not operating in continuous mode). You cannot turn off or change the LED flashing functions.

There are three audible alarm options, represented by three icons as shown below.

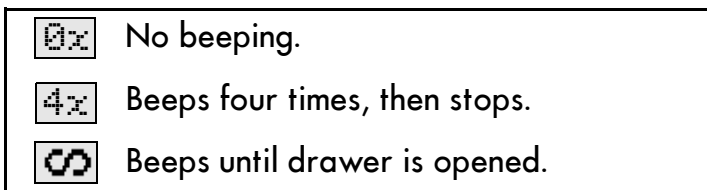

definition of beeper icons

The audible alarm can be turned off completely, it can beep momentarily when the sample is finished and then stop, or it can beep continuously until the knob is turned to the OPEN/LOAD position.

EXIT

You may press the EXIT button (the lower left button) to exit back to the main measurement screen at any time.

Adjusting for linear offset

When you need to adjust for linear offset, press the upper right button in the system configuration menu, and you will be brought to the linear offset menu. For more details on linear offset and how to verify for it, please refer to Chapter 7.

6. Cleaning and Maintenance

Keeping your AquaLab clean is vital to maintaining the accuracy of your instrument. Dust and sampling debris can contaminate the sampling chamber and must therefore be regularly cleaned out. To clean your instrument, carefully follow these instructions and refer to the labeled diagram below.

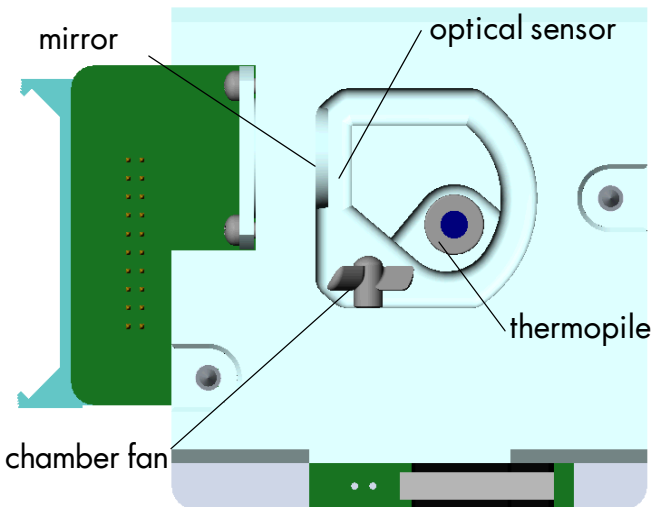

View of inside block chamber

Purpose

The purpose for the cleaning procedure is to remove grease, dirt and other soluble substances which can

AquaLab

6. Cleaning and Maintenance

absorb/release water during verification, calibration, and/or sample testing. For a smooth and even dew formation, it requires the mirror to be perfectly clean. If there are any contaminants (e.g. fingerprints) on the mirror, the dew will form unevenly and thus affect the accuracy of the reading.

Materials Needed

- A thin plastic rod or other non-metal implement
- Distilled Water
- Isopropyl Alcohol (IPA) or Decagon Cleaning Solution
- Kimwipes®

You may also purchase the AquaLab Cleaning Kit which comes with all the above materials except the Isopropyl Alcohol and Distilled Water.

NOTE: Wash your hands with soap and water and/or use clean lab gloves before starting the cleaning procedure. This will prevent oils from contaminating the cleaning materials, the sample chamber and/or the sensors.

Cleaning the Block and Sensors

Accessing the Block

Turn the power off on your AquaLab (switch in back.) Next, remove the case lid screw located on the back panel. Carefully remove the lid by pulling the back of the lid upward and then sliding the lid back (away from the front

of the case) and off. Unscrew the two thumbscrews that secure the sensor block. Unplug the cable with the 20-pin socket that attaches the block to the main circuit board by releasing the two locking levers that are on either side of the socket. Carefully lift the block straight up from its mount. Turn the block over to expose the chamber cavity as shown in the illustration at the beginning of this chapter.

NOTE for Volatiles Block: If cleaning an AquaLab Series 3 Volatiles Block, follow the cleaning procedures listed below being especially careful not to get cleaning solution or alcohol on the capacitance sensor filter. Repeated exposure of cleaning materials or contaminants to the filter may cause inaccurate readings. If the filter appears contaminated, replace it while being careful not to disturb the sensor behind the filter.

Cleaning Procedure:

Cleaning your AquaLab is a multi-step procedure which involves washing, rinsing, and drying for each specific area as outlined below:

1. Cleaning the Sample Chamber

Note: Be extremely careful not to damage the fan blades (see illustration) when cleaning the chamber.

- a. Remove any debris that may have collected within or around the sample chamber.
- b. Wrap a NEW Kimwipe around the end of the thin

AquaLab

ó. *Cleaning and Maintenance*

plastic rod (spatula) and moisten it with isopropyl alcohol or Decagon Cleaning Solution. Note: Do NOT dip a used Kimwipe into your container of IPA or cleaning solution (the IPA or cleaning solution will become contaminated).

- c. WASH--Clean all surface edges of the samples chamber including the edge where the sample cup seals to the chamber block. You may need to replace the Kimwipe if it becomes too dirty during this process.
- d. RINSE--Repeat steps b and c using new Kimwipes with distilled water.
- e. DRY--Repeat steps b and c using new, dry Kimwipes to help remove any moisture remaining from the cleaning.
- f. Visually inspect the sample chamber for cleanliness. Re-clean if necessary. *Note: Do not reuse Kimwipes.*

2. Clean the Mirror

- a. Wrap a new Kimwipe around the end of the thin plastic rod (spatula) and moisten it with isopropyl alcohol or Decagon Cleaning Solution.
 - b. WASH--Swipe the moistened Kimwipe across the mirror once. (A single swipe is usually sufficient to remove contaminants.)
 - c. RINSE--Repeat steps a-b using new Kimwipes moistened with distilled water instead of cleaning solution.
-

- d. DRY--Repeat steps a-b using new, dry Kimwipes to help remove any moisture remaining from the cleaning.
- e. Visually inspect the mirror for cleanliness. Re-clean if necessary.

3. Clean the Thermopile and Optical Sensor

- a. Wrap a new Kimwipe around the end of the thin plastic rod (spatula) and moisten it with isopropyl alcohol or Decagon Cleaning Solution.
- b. WASH--Swipe the moistened Kimwipe across thermopile and optical sensor. (A single swipe is usually sufficient to remove contaminants.)
- c. RINSE--Repeat steps a-b using new Kimwipes moistened with distilled water instead of cleaning solution.
- d. DRY--Repeat steps a-b but use a new, dry Kimwipe to help remove any moisture remaining from the cleaning.
- e. Visually inspect the thermopile and optical sensor for cleanliness. Re-clean if necessary.

4. Additional Drying Time

- a. Visually inspect the sample chamber and sensors for contaminants, including moisture. If necessary, repeat the cleaning process using new Kimwipes.
- b. Let stand for about 5 minutes to ensure the sample chamber is dry.

Checking Calibration

After you have cleaned the chamber and other parts of your AquaLab, it is important to check the instrument's performance in order to correct for any linear offset that may have occurred during the cleaning process.

Before you check the instrument we recommend that you run a sample of the activated charcoal pellets provided in your AquaLab cleaning kit. This cleans the air inside the chamber, helping it come back to a stable sampling environment.

Verify the linear offset against known calibration standards according to the procedure described in the next chapter. If a linear offset has occurred, refer to “adjust for linear offset” section in Chapter 7 for directions on how to correct for linear offset. If, after adjusting for linear offset, your instrument is still not reading samples correctly, please contact Decagon for support.

7. Verification and Calibration

It is important to verify AquaLab's water activity calibration against known standards to guarantee optimal performance and accuracy. Decagon recommends verification daily, once per shift, or before each use (if used infrequently).

Water Activity Verification

AquaLab uses the chilled-mirror dewpoint technique to determine water activity. Because this is a primary measurement of relative humidity, no calibration is necessary; however, it is important to check for linear offset periodically. The components used by the instrument to measure water activity are subject to contamination which may affect the AquaLab's performance. When this occurs, it changes the accuracy of the instrument. This is what is called a "linear offset." Therefore, frequent verification assures you that your AquaLab is performing correctly. Linear offset is checked by using two different calibration standards.

Calibration Standards

Calibration standards are specially prepared salt solutions having a specific molality and water activity constant which are accurately measurable. The calibration standards

AquaLab

7. Verification and Calibration

that were sent with your initial shipment are very accurate and readily available from Decagon. Using calibration standards to verify accuracy can greatly reduce preparation errors. For these reasons, we recommend using standards available through Decagon for the most accurate verification of your AquaLab's performance.

Performance Calibration Standards come in five water activity levels: 1.000, 0.984, 0.760, 0.500, and 0.250_{a_w}. The standards are produced under a strict quality assurance regime. Please contact Decagon Devices to order additional standards via sales@decagon.com or 1-800-755-2751.

Calibration Standard @25°C	Water Activity
Distilled Water	1.000 ±0.003
0.5m KCl	0.984 ±0.003
6.0m NaCl	0.760 ±0.003
8.57m LiCl	0.500 ±0.003
13.41m LiCl	0.250 ±0.003

NOTE: If you need to obtain a Material Safety Data Sheet (MSDS) for any of these standards, a printable version is available on our website at www.decagon.com/msds.

To use a calibration standard, remove the twist top and

pour the contents into an AquaLab sample cup. If for some reason you cannot obtain Decagon's calibration standards and need to make a saturated salt solution for verification, refer to Appendix A.

Calibration

When to Verify for Linear Offset

Linear offset should be checked against two known calibration standards either daily, once per shift or before each use. Linear offset should never be verified solely against distilled water, since it does not give an accurate representation of the linear offset. For batch processing, the instrument should be checked regularly against a known standard of similar water activity. It is also a good idea to check the offset with a standard of similar water activity when the general water activity range of your sample is changing. Checking the water activity of a standard solution will alert you to the possibility of unit contamination or shifts in the linear offset from other causes.

Note: The calibration process is the same for both the dewpoint and volatiles block except that the accuracy for the capacitance sensor in the volatiles block is $\pm 0.015 a_w$.

Verification

To verify for linear offset of your AquaLab, do the following:

1. Choose a calibration standard that is close to the water activity of the sample you are measuring. *Note: The AquaLab needs to warm up for approximately 15 minutes to make accurate readings.*

AquaLab

7. Verification and Calibration

2. Empty a vial of the chosen calibration standard into a sample cup and place it in the AquaLab's sample drawer. Make sure that your standard is as close to the instrument temperature as possible.

Note: Make sure the rim of the sample cup is clean.

3. Carefully slide the drawer closed and turn the knob to the READ position.
4. Take two readings. The water activity readings should be within $\pm 0.003a_w$ of the given value for the calibration standard. See Appendix B for the correct water activity value of Decagon's standards at temperatures other than 25°C.
5. If your AquaLab is reading within $\pm 0.003a_w$ of the calibration standard, chose a second calibration standard that would border the range of water activity you plan to test. For example, if you plan to test for water activity readings ranging between 0.713 and 0.621 you should use the 6.0M, NaCl ($0.76a_w$) standard for your first verification and the 8.57M LiCl ($0.50a_w$) for the second verification.
6. Prepare a sample cup of the second calibration standard and make two readings. The water activity reading for the second calibration standard should be within $\pm 0.003a_w$

7. If either one of the verifications is not correct, it is probably due to contamination of the sensor chamber. For cleaning instructions, see Chapter 6. After cleaning, repeat verification from step two.
8. If you are consistently getting readings outside the water activity of your first calibration standard by more than $\pm 0.003a_w$, a linear offset has probably occurred. In this case, adjust the reading on the calibration standard to its correct value as outlined in the next section.

Adjusting for Linear Offset

1. Once you are certain that a linear offset has occurred, enter the system configuration menu by pressing the lower left button from the measurement screen. Press the upper right button in the system configuration menu to enter the linear offset menu. You will be guided through the linear offset routine.
2. If you wish to continue, press the button next to “yes.” To return to the measurement screen, press the button next to “no.” After selecting “yes,” the following screen will appear:



```
place standard
in drawer and read
```

AquaLab

7. Verification and Calibration

3. Empty the whole vial of a calibration standard into a sample cup. We recommend using the 6.0M NaCl (0.76a_w). Do not adjust for the offset using distilled water. Ensure the rim and outside of the cup are clean. Place the prepared sample cup in the AquaLab's sample drawer.

NOTE: The same calibration standard may be used to verify and adjust the linear offset.

4. Close the drawer, being especially careful so the solution won't splash or spill and contaminate the chamber.
5. Turn the drawer knob to the READ position to make a water activity reading.

Note: If you decide at this point not to continue with the linear offset program, just return the knob to the OPEN/LOAD position and remove the sample.

After your AquaLab has finished sampling the calibration standard, it will display the following screen:

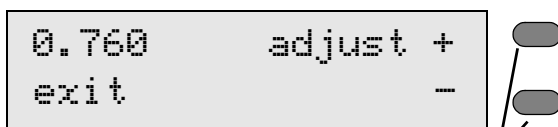

use these buttons to adjust the value

6. Adjust the water activity value to its proper value for the particular calibration standard you are measuring by pressing the up or down buttons until the correct value is displayed. When the value is correct, press the Exit button to store this new value.

Note: This is the only menu where these buttons can change the linear offset, so you won't hurt anything by pressing these buttons in other menus.

7. Re-measure the calibration standard again in the normal sampling mode. It should read the proper value at a given temperature for that calibration standard (see Appendix B).
8. Measure the water activity of a second calibration standard according to the verification procedure described above. If both verification readings are within $\pm 0.003a_w$ then the instrument is ready to begin testing.

If you still have incorrect verification readings after cleaning the chamber and/or adjusting for linear offset, contact Decagon for further instructions at support@decagon.com or 1-800-755-2751 or 509-332-2756. If you purchased your AquaLab from one of our international distributors, please contact them for local service and support.

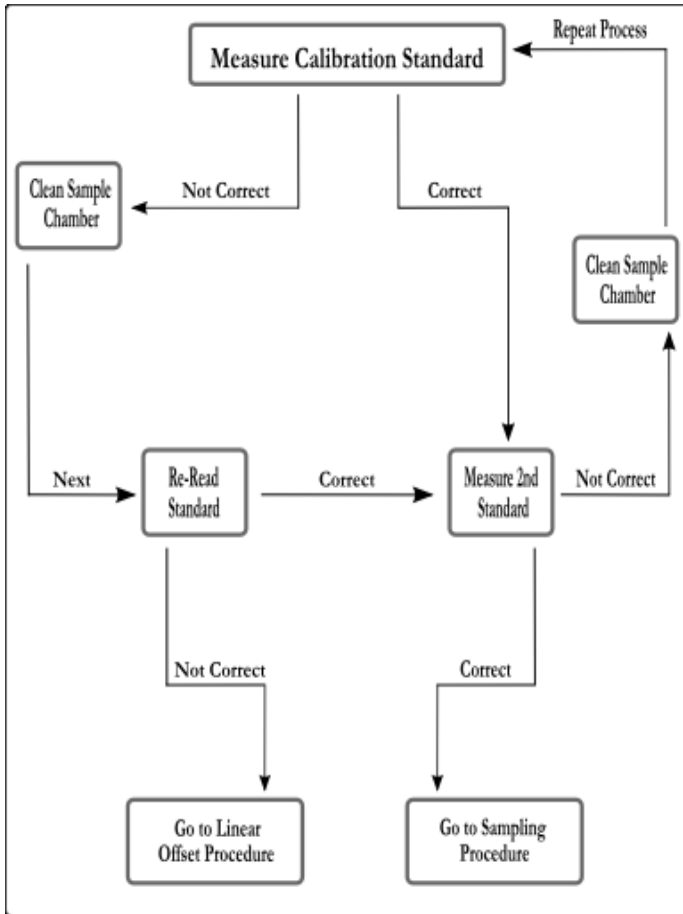

This flowchart is a graphical representation of the directions given above for checking for linear offset.

8. Sample Preparation

Your AquaLab will continually provide accurate water activity measurements as long as its internal sensors are not contaminated by improperly-prepared samples. Careful preparation and loading of samples will lengthen time between cleanings and will help you avoid cleaning and downtime.

Preparing the Sample

To prepare a sample, follow these steps:

1. **Make sure that the sample to be measured is homogeneous.** Multi-component samples (e.g., muffins with raisins) or samples that have outside coatings (like deep-fried, breaded foods) can be measured, but may take longer to equilibrate. For samples like these, AquaLab may take more than five minutes to give an accurate reading, or may require multiple readings of the same sample. Measuring the water activity of these types of product is discussed in detail later in this chapter (see Materials Needing Special Preparation).
2. **Place the sample in a disposable sample cup, completely covering the bottom of the cup, if possible.** AquaLab is able to accurately measure a sample that does not (or cannot) cover the bottom of the cup.

For example, raisins only need to be placed in the cup and not flattened to cover the bottom. A larger sample surface area increases instrument efficiency by providing more stable infrared sample temperatures. It also speeds up the reading by shortening the time needed to reach vapor equilibrium.

- 3. Do not fill the sample cup more than half full. Overfilled cups will contaminate the sensors in the sensor chamber!** Filling the sample cup will not make the readings faster or more accurate. There only needs to be enough sample in the cup to allow the water in the sample to equilibrate with the water in the vapor phase and not change the moisture content of the sample. There is a minimum amount of sample needed; therefore, covering the bottom of the sample cup is normally enough.
- 4. Make sure that the rim and outside of the sample cup are clean.** Wipe any excess sample material from the rim of the cup with a clean tissue. Material left on the rim or the outside of the cup will contaminate the sensor chamber and be transferred to subsequent samples. The rim of the cup forms a vapor seal with the sensor block when the drawer knob is turned to the READ position. Therefore, any sample material left on the cup rim will be transferred to the block, preventing this seal and contaminating future samples.

5. **If a sample will be read at some other time, put the sample cup's disposable lid on the cup to restrict water transfer.** For long-term storage, seal the lid by placing tape or Parafilm™ completely around the cup/lid junction. It is necessary to seal the cup if it will be a long time before the measurement is made.

Samples Needing Special Preparation

AquaLab reads most materials in less than five minutes, depending on which mode you are operating in. Some samples, however, may require longer reading times, due to the nature of the material you are sampling. These materials need additional preparation to ensure quick, accurate readings. To find out whether special sample preparation is necessary, take a reading and see how long it takes to find the water activity. If it takes longer than six minutes, remove the sample and take a reading of a calibration standard. This will ensure that the sample itself is causing the long read time, and that there is not a problem with your instrument. If the calibration standard also takes longer than six minutes to sample, refer to Chapter 11 of this manual for more information.

Coated and Dried Samples

Samples with coatings such as sugar or fat often require longer reading times, because it takes longer for them to equilibrate. If this is the case for your samples, don't worry

AquaLab

8. Sample Preparation

that something is wrong with your instrument; it simply means that your particular sample takes longer than most to equilibrate water with its outside environment.

To reduce the time needed to take a water activity reading for coated or dried samples, one thing you can do is crush, slice, or grind the sample before putting it in the sample cup. This increases the surface area of the sample, thus decreasing reading times. Keep in mind, however, that modifying some samples may alter their water activity readings.

For example, a candy may have a soft chocolate center and a hard outer coating. The water activity reading for the center and the outer coating are different, so one would need to evaluate which part of the sample needed to be measured before crushing it. When the candy is crushed, for example, the water activity will represent the average water activity of the entire sample; whereas leaving the candy whole will give a reading for the coating, which may act as a barrier to the center.

Note: if you crush, grind, or slice your sample, be consistent in the method you use in order to obtain reproducible results.

Slow Water-Emitting Samples

Some extremely dry, dehydrated, highly viscous water-in-oil (butter), high fat, or glassy compositions may have increased read times, due to their moisture sorption characteristics. AquaLab may require up to ten minutes to

reach an accurate measurement of water activity and nothing can be done to decrease the reading times of these types of samples.

For faster reading, it is important to have the water activity of the chamber at or below the water activity of these type of samples. This causes the sample to release water to the vapor phase and equilibrate with the chamber. If the water activity of the headspace is greater than this type of sample, a long period of time will be required to reach equilibrium and the water activity of the sample may be affected.

Volatile Samples

AquaLab will give accurate readings on most samples. However, samples with certain volatiles in high enough concentrations may give inaccurate water activity values. This is because the volatiles condense on the mirror during the reading process, but do not evaporate from the mirror as water does. As a result, the reading on volatiles will not be accurate. The concentration of volatiles that will cause interference is variable and matrix dependent. The most effective method to determine if volatiles are a problem is to look for incorrect standard readings after reading the sample.

If you will be testing samples with volatiles on a regular basis that need a more accurate reading, you should consider upgrading to the Decagon's Series 4TEV which is designed for measuring volatiles such as propylene glycol

AquaLab

8. Sample Preparation

and ethanol. For more information about the Series 4TEV, contact Decagon Devices at support@decagon.com or 1-800-755-2751 or 509-332-2756.

Low Water Activity

Samples that have a water activity of less than about 0.03 cannot be accurately measured with the normal AquaLab Series 3 model. Samples with such low water activity values are rare. When a sample's water activity value is below its ability to accurately measure, your AquaLab will display an error message indicating the last reading it could make on that particular sample. For example, say you are measuring a dry sample and the following screen appears:

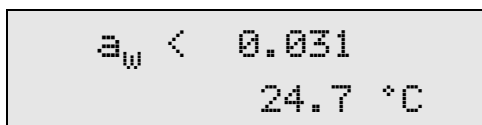

```
a_w < 0.031
      24.7 °C
```

This screen indicates that the last water activity reading the AquaLab measured on this sample was 0.031 at 24.7°C. Therefore, the actual water activity of the sample is lower than the instrument's components can measure.

If your sample is not extremely dry but is still getting the error message, refer to Chapter 11 for other possible explanations.

Samples not at Room Temperature

Samples that are 4 degrees colder or warmer than the instrument (chamber) temperature will need to equilibrate

to ambient temperature before a fast, accurate reading can be made. Rapid changes in temperature over short periods of time will cause the water activity readings to rise or fall until the temperature stabilizes. When the temperature stabilizes within one or two degrees of the chamber temperature, you can proceed with normal measurements.

High-water activity samples that are warmer than the chamber temperature can cause condensation inside the measuring chamber, which will adversely affect subsequent readings. A warning message appears (`Sample too hot`) if the sample temperature is more than 4°C above chamber temperature. If this message appears, immediately remove the sample from the instrument, place a lid on the cup, and allow the sample to cool to within 4°C of the instrument before measuring.

Samples that are lower than 4°C of the instrument's temperature will cause long read times. The sample temperature must be within one or two degrees of the chamber temperature before fast, accurate readings can be made.

9. Taking a Reading

Measurement Steps

Once you have prepared your sample, you are ready to take readings. The process is simple:

1. Turn the sample drawer knob to the OPEN/LOAD position and pull the drawer open.
2. Place your prepared sample in the drawer. Check the top lip of the cup to make sure it is free from sample residue (remember, an over-filled sample cup may contaminate the chamber's sensors).
3. Carefully slide the drawer closed, being especially careful if you have a liquid sample that may splash or spill and contaminate the chamber.
4. Turn the sample drawer knob to the READ position to seal the sample cup with the chamber. The following screen will appear:



```
chamber sealed  
measurement started
```

This will start the read cycle. Length of read times

may vary depending on temperature differences between the chamber and your sample, and other properties of your sample.

Note: Samples that have a large difference in water activity from previous samples may need extra time to reach equilibrium, since some of the previous sample's atmosphere stays in the chamber after measurement.

How AquaLab takes Readings

AquaLab's reading cycle continues until the rate of change of three consecutive readings are less than 0.0005 of each other. The instrument crosses the dew threshold numerous times to ensure the accuracy of readings. When the instrument has finished its read cycle, the water activity is displayed, accompanied by the LED flash and beeper (if you have the beeper enabled).

Cautions

- **Never leave a sample in your AquaLab after a reading has been taken. The sample may spill and contaminate the instrument's chamber if the instrument is accidentally moved or jolted.**
- **Never try to move your instrument after a sample has been loaded. Movement may cause the sample material to spill and contaminate the sample chamber.**

AquaLab

9. Taking a Reading

- Take special care not to move the sample drawer too quickly when loading or unloading liquid samples, in order to avoid spilling.
- If a sample has a temperature that is four degrees higher (or more) than the AquaLab's chamber, the instrument will display a message (below)

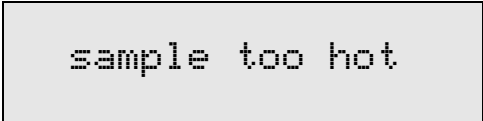

sample too hot

alerting you to cool the sample before reading. Although the instrument will measure warmer samples, the readings may be inaccurate. Warm samples can cause condensation in the chamber if they have a high water activity.

- The physical temperature of the instrument should be between 4°- 50°C. Between these ambient temperatures, AquaLab will measure samples of similar temperature quickly and accurately.
- If you are sampling and a triangular warning symbol appears in the top right corner, this indicates



0.853 a_w Δ

24.7°C

that the mirror has become too dirty to give accurate measurements, and you need to clean the mirror and chamber before continuing to sample. For more details about this symbol, please refer to Chapter 11. For cleaning instructions, refer to Chapter 6.

- If a sample has a water activity lower than about 0.03, AquaLab will display a message, accompanied by the flashing light, notifying you that your sample is too dry to be accurately measured by the AquaLab. Following is an example:

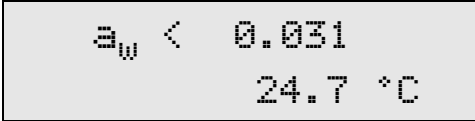

$a_w < 0.031$
24.7 °C

This message will stay on the screen until you open the sample drawer. If you know that your sample's water activity is above what the screen is telling you, your instrument's sensors may have been contaminated and will need to be cleaned (see Chapter 6) or serviced (see Chapter 12).

10. Computer Interface

Your AquaLab was shipped to you with a standard RS-232 interface cable. Using this, you can use your computer's terminal program to send water activity data to your computer for further analysis and storage.

AquaLink Software

An optional program that is available for use with your AquaLab is AquaLink. AquaLink is a Windows-based program designed for collection and graphing of data from all AquaLab models. It logs water activity, temperature, time of measurement, and a time and date stamp (from your computer's clock). It also has sample identification and comments fields that you can use to help annotate the data that your AquaLab is taking. AquaLink takes the data and displays it in a real-time graph. You can control the increments of each axis to customize the graph as you wish. If you are interested in purchasing a copy of AquaLink, contact Decagon or your authorized distributor. Here is a sample picture of the AquaLink program:

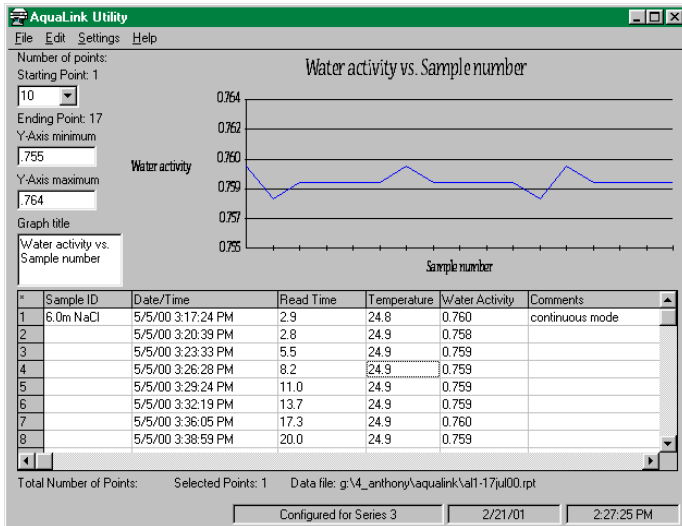
*AquaLink screen*

Using Windows Hyperterminal

To use Hyperterminal with your AquaLab, follow these steps:

1. Press the Start button and select Programs > Accessories > Hyperterminal and click on the Hyperterminal icon.
2. At the prompt, choose a name for this program (AquaLab is a good one) and choose an arbitrary icon above to represent it. In future downloads, you will be able to click on this icon in have it already set up for you to download. Click the OK button.

11. Troubleshooting

AquaLab is a high performance instrument, designed to have low maintenance and few problems if used with care. Unfortunately, sometimes even the best operators using the best instruments encounter technical difficulties. Below is quick reference guide that will direct you to detailed solutions of some problems that may occur. If these remedies still don't resolve your problem, then please contact Decagon for help (see Chapter 12: Support and Repair).

Troubleshooting Quick Guide

<u>If this problem occurs:</u>	<u>Refer to:</u>
AquaLab won't turn on	Problem #1
Readings are slow or inconsistent	Problem #2
Water activity readings on solutions are..... too high/low to adjust	Problem #3
Screen displays "Sample too hot"	Problem #4
Screen displays " $a_w < x.xxx$ "	Problem #5

Troubleshooting Quick Guide (continued)

<u>If this problem occurs:</u>	<u>Refer to:</u>
Screen displays “ $a_w > 1.0$ ”	Problem #6
Verification not correct	Problem #7
Triangle appears in upper right corner.....	Problem #8
Screen displays “Block failure”	Problem #9
turning on AquaLab	

PROBLEM #1:

AquaLab won't turn on.

SOLUTION:

- 1) **Check to make sure your power cord is securely attached** to the back of the instrument and it is plugged into the power outlet.
- 2) **A power surge may have caused a fuse to blow.** To change the fuses, follow these instructions:
 - a. Unplug the power cord .
 - b. Locate the panel where the power cord plugs in. The fuse box is on the right side of that panel. Press in on the release tab and pull the fuse-holder out. Pull the broken fuse(s) out and replace with a 1.25 Amp 250V fuse.

AquaLab

11. Troubleshooting

Caution: Do not use any other kind of fuse or you will risk damage to your instrument as well as void your warranty.

- c. Replace the fuse-holder and push it into the fuse-well until the release tab snaps in place.

- d. Re-connect the power cord and turn your instrument on. If the fuse blows again, a failed component may be causing the problem. Contact Decagon to make arrangements for repairs.

PROBLEM #2:

Readings are slow or inconsistent.

SOLUTION:

- 1) **The sample chamber may be dirty.** Refer to Chapter 6 of the manual for directions on cleaning the sample chamber.

- 2) **Some products absorb or desorb moisture very slowly,** causing measurements to take longer than usual, and nothing can be done to speed up the process. Refer to Chapter 8 for further explanation.

- 3) **Your sample may contain volatiles.** Volatiles are known to cause unstable readings, because they con-

dense on the surface of the chilled mirror and alter readings. Please refer to the volatiles section in Chapter 8 for hints on reducing difficulties with measuring samples with propylene glycol. If you have further questions regarding the measurement of volatiles contact Decagon.

- 4) **A fan blade in the block chamber may be broken or bent.** If even salt standards take a long time to read, and the sample chamber is clean, you may have a broken chamber fan blade. This is especially likely if you have just cleaned the chamber. If you suspect this may have happened, contact Decagon for details on replacement.

PROBLEM #3:

Water activity readings on calibration standards are too high/low and a linear offset adjustment cannot be made any higher/lower.

SOLUTION:

- 1) **The thermopile in your chamber, which measures sample temperature, may have become contaminated.** Refer to Chapter 6 for directions on cleaning.
- 2) **The chamber mirror may be dirty.** Refer to Chapter 6 for directions on cleaning.

PROBLEM #4:

Message on screen displays the following:



```
sample too hot
```

SOLUTION:

- 1) **Your sample's temperature is too high for the instrument to equilibrate** with it in a reasonable amount of time. The instrument and sample need to be in temperature equilibrium before accurate samples can be made. Therefore, very cold samples will take a very long time to measure for the same reason. To avoid this problem, make sure to only measure samples that are at the same temperature as the instrument.

PROBLEM #5:

Message on screen displays the “<“ symbol.



```
a_w < 0.028  
24.7 °C
```

SOLUTION:

- 1) **The sample is too dry** for the instrument to read accurately. If your sample has a water activity that is less than below the detection limits of the instrument,

this message will come up. Essentially, it means that there is not enough sample moisture to condense on the mirror and provide a reading.

- 2) **The mirror may be dirty.** Try cleaning the mirror and chamber and measuring the sample again.

PROBLEM #6:

Message on screen displays “ $a_w > 1.0...$ ”

SOLUTION:

The Cooler is damaged and will need to be serviced by Decagon. See Chapter 12 for detailed instructions.

PROBLEM #7:

Verification is not correct.

SOLUTIONS:

- 1) **The sample chamber and mirror need to be cleaned.** See Chapter 6 for detailed cleaning instructions. If verification is still not correct, then linear offset has occurred.
- 2) **Verify and Adjust for Linear Offset.** After you have cleaned the sample chamber and mirror (Chpt. 6) you will need to use a Calibration Standard to verify and adjust for Linear Offset as described in Chapter 7.

PROBLEM #8:

A small triangle appears in the upper right corner after sampling:

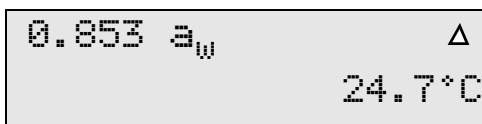
**SOLUTION:**

- 1) **The mirror needs to be cleaned**, along with the rest of the sample chamber, or a volatile contaminant is interfering with the dewpoint determination. This triangle is a mirror performance indicator. The performance of the mirror is measured on a 0 to 1 scale, with 1 being the cleanest. When the AquaLab senses that the mirror performance has dropped to unacceptable levels, it will display the triangular warning sign after the sample has been measured. To see what the mirror performance value is, press the upper right button when the triangle appears, and it will show you the value. At this point, you should stop sampling and clean the chamber. If the triangle is still on the screen after cleaning, the mirror is most likely still dirty or a volatile in your sample is contaminating the mirror. Contact Decagon for more assistance.

PROBLEM #9:

The following screen comes up after turning on the machine:



```
block failure
```

SOLUTIONS:

- 1) **The block is not plugged in to the motherboard.**
Open the case and check to make sure that the small ribbon cable that connects the block to the motherboard is snapped and locked in place.
- 2) **One or more components has failed on the block's circuit board.** If the block is properly plugged in to the motherboard and this message appears, it is likely that one or more of the components have failed on the block's circuit board. If you press `-exit-` at this prompt, the instrument will not have values for the component that has failed, which will lead to incorrect readings. If this message appears and you continue to sample, Decagon cannot be liable for errors in reading that may occur. Contact Decagon for a solution to this problem.

Component Performance Screen

If, after cleaning your instrument and reading the other troubleshooting hints, you have reason to believe that one of the components of your AquaLab may be causing measurement error, you can access a screen that will display values for component performance. This is done either by holding down the lower right button while turning on the instrument, or by first pressing the lower left button (system configuration menu), then the upper right button (linear offset menu) and then the upper left button.

The following screen will appear:

```
sensors  3.21  0.030
-Exit-   23.5  1100
```

This screen gives you four values. The top left value is the value the thermocouple is reading. It is basically the difference in temperature between the block and the mirror. It should typically have a value of 3, ± 0.3 . If this is zero, there is something wrong with the thermocouple. The top right value is the value read by the thermopile, which is the temperature difference between the block and what it “sees” below it (the sample, when reading). This value should be around zero, but will change when you change the drawer position. The bottom left value is the block temperature. This value should be around ambient temperature. The bottom right value is the mirror reflectance

voltage, in units of millivolts. This value should normally be between 400 and 2400mV, and should be steady.

You can't change anything in this screen, but it is here to give you an indication of the component performance. If you notice that any of these values are not what they should be, contact Decagon for further instruction. Press the button next to `-Exit-` to get back to the main menu.

12. Support and Repair

NOTE: If you purchased your AquaLab from one of our international distributors, please contact them. They will be able to provide you with local support and service.

When encountering problems with your AquaLab (that can't be resolved with the help of this manual), please contact Decagon Customer Support at **support@decagon.com**, 800-755-2751 (US and Canada), 509-332-2756 (International) or fax us at (509) 332-5158. Please have the serial number and model of the instrument ready.

All AquaLabs returning to Decagon for servicing must be accompanied with a Return Material Authorization (RMA) form. Prior to shipping the instrument, please contact a Decagon customer support representative to obtain an RMA.

Shipping Directions:

The following steps will help to ensure the safe shipping and processing of your AquaLab.

1. Ship your AquaLab in its original cardboard box with suspension packaging. If this is not possible, use a box that has at least 4 inches of space between your instrument and each wall of the box.

2. Place an empty sample cup in the sample drawer to help protect it from damage during shipping.
3. Place the AquaLab in a plastic bag to avoid disfiguring marks from the packaging.
4. **Don't ship the power cord or serial cable.**
5. If the original packaging is not available, pack the box moderately tight with packing material (e.g. styrofoam peanuts or bubble wrap), ensuring the instrument is suspended in the packing material.
6. Include a copy of the RMA form in the shipment. Please verify the ship to and bill to information, contact name, and problem description. If anything is incorrect, please correct it on the RMA form or contact a Decagon representative.
7. Tape the box in both directions for added support.
8. Include the RMA number in the attention line on the shipping label.

Ship to:

Decagon Devices Inc.

ATTN: RMA (insert your RMA #)

2365 NE Hopkins Court

Pullman, WA 99163

AquaLab

12. Support and Repair

Repair Costs

Manufacturer's defects and instruments within the three-year warranty will be repaired at no charge. Non-warranty repair charges for parts, labor and shipping will be billed to you. An extra fee may be charged for rush work. Decagon will provide an estimated repair cost, if requested.

Loaner Service

Decagon has loaner instruments to keep you measuring water activity while your instrument is being serviced. If your AquaLab is still under calibration warranty or you have a service plan with your instrument, there is no charge for the loaner service.

13. Further Reading

Water Activity Theory & Measurement

Bousquet-Ricard, M, G. Qualyle, T. Pharm, and J.C. Chef-tel. (1980). Comparative study of three methods of determining water activity in intermediate moisture foods. *Lebensmittel-Wissenschaft und-Technologie*.13:169-173.

Chirife, J., G. Favetto, C. Ferro-Fontan, and S. Resnik. (1983). The water activity of standard saturated salt solutions in the range of intermediate moisture foods. *Lebensmittel-Wissenschaft und-Technologie*. 16:36-38.

Duckworth, R. (1975). *Water Relations of Foods*. Academic Press, New York.

Gomez-Diaz, R. (1992). Water activity in foods: Determination methods. *Alimentaria*. 29:77-82.

Gómez, R. and Fernandez-Salguero J. (1992). Water activity and chemical composition of some food emulsions. *Food Chemistry*. 45:91-93.

Greenspan, L. (1977). Humidity fixed points of binary saturated aqueous solutions. *Journal of Research of the National Bureau of Standards - A.Physics and Chemistry*. 81A:89-96.

Karmas, E. (1981). Measurement of moisture content. *Cereal Foods World*. 26(7):332-334.

Kitic, D., D.C. Pereira-Jardim, G. Favetto, S.L. Resnik, and J. Chirife. (1986). Theoretical prediction of the water activity of standard saturated salt solutions at various temperatures. *Journal of Food Science*. 51:1037-1042.

Labuza, T.P. and R. Contreras-Medellin. (1981). Prediction of moisture protection requirements for foods. *Cereal Foods World*. 26(7):335-343.

Labuza, T.P., K. Acott, S.R. Tatini, and R.Y. Lee. (1976). Water activity determination: A collaborative study of different methods. *Journal of Food Science*. 41:910-917.

Prior, B.A. (1979). Measurement of water activity in foods: A review. *Journal of Food Protection*. 42(8):668-674.

Reid, D.S. (1976). Water activity concepts in intermediate moisture foods. In: *Intermediate Moisture Foods*. Davies, R., G.G. Birch, and K.J. Parker (ed.) Applied Science Publishers, London. pp. 54-65.

Richard, J. and T.P. Labuza. (1990). Rapid determination of the water activity of some reference solutions, culture media and cheese using a new dew point apparatus. *Sciences des Aliments*. 10:57-64.

Roa, V. and M.S. Tapia de Daza. (1991). Evaluation of water activity measurements with a dew point electronic humidity meter. *Lebensmittel-Wissenschaft und-Technologie*. 24(3):208-213.

Roos, K.D. (1975). Estimation of water activity in intermediate moisture foods. *Food Technology*. 29:26-30.

Scott, V.N. and D.T. Bernard. (1983). Influence of temperature on the measurement of water activity of food and salt systems. *Journal of Food Science*. 48:552-554.

Snively, M.J., J.C. Price, and H.W. Jun. (1990). A comparison of three equilibrium relative humidity measuring devices. *Drug Development and Industrial Pharmacy*. 16(8):1399-1409.

Stamp, J.A., S. Linscott, C. Lomauro, and T.P. Labuza. (1984). Measurement of water activity of salt solutions and foods by several electronic methods as compared to direct vapor pressure measurement. *Journal of Food Science*. 49:1139-1142.

Stoloff, L. (1978). Calibration of water activity measuring instruments and devices: Collaborative study. *Journal of Association of Official Analytical Chemists*. 61:1166-1178.

Troller, J.A. (1983). Methods to measure water activity. *Journal of Food Protection*. 46:129-134.

Troller, J.A. and J.H.B. Christian. (1978). *Water Activity and Food*. Academic Press, New York.

Troller, J.A. and V.N. Scott. (1992). Measurement of water activity (a_w) and acidity. In: *Compendium of Methods for the Microbiological Examination of Foods*. Vanderzant, C. and D.F. Splittstoesser (ed.) American Public Health Association, Washington, D.C. pp. 135-151.

Van den Berg, C. (1985). Water activity. In: *Concentration and Drying of Foods*. MacCarthy, D. (ed.) Elsevier, London. pp. 11-35.

Van den Berg, C. (1991). Food-water relations: Progress and integration, comments and thoughts. In: *Water Relationships in Foods*. Levine, H. and L. Slade (ed.) Plenum Press, New York.

Van den Berg, C. and Bruin. (1981). Water activity and its estimation in food systems: Theoretical aspects. In: *Water Activity: Influences on Food Quality*. Rockland, L.B. and G.F. Stewart (ed.) Academic Press, New York. pp. 1-61.

Vega, M.H. and G.V. Barbosa-Canovas. (1994). Prediction of water activity in food systems: A review on theoretical models. *Revista Espanola De Ciencia Y Tecnologia De Alimentos*. 34:368-388.

Vega, M.H., B. Romanach, and G.V. Barbosa-Canovas.

(1994). Prediction of water activity in food systems: A computer program for predicting water activity in multi-component foods. *Revista Espanola De Ciencia Y Tecnologia De Alimentos*. 34:427-440.

Vos, P.T. and T.P. Labuza. (1974). Technique for measurements of water activity in the high a_w range. *Journal of Agricultural and Food Chemistry*. 22:326-327.

Voysey, P. (1993). An evaluation of the AquaLab CX-2 system for measuring water activity. *Digest, Microbiology Section*. 124

Food Quality and Safety

Brandt, L. (1996). Bound for success. Controlling water activity gives technologists the edge in developing safe, shelf-stable foods. *Food Formulating*. September:41-48.

Chirife, J. and B.M. Del-Pilar. (1994). Water activity, glass transition and microbial stability in concentrated/semi-moist food systems. *Journal of Food Science*. 59:921-927.

Chirife, J. and M.P. Buera. (1995). A critical review of some non-equilibrium situations and glass transitions on water activity values of foods in the microbiological growth range. *Journal of Food Engineering*. 25:531-552.

Chirife, J. and M.P. Buera. (1996). Water activity, water glass dynamics, and the control of microbiological growth

in foods. *Critical Reviews in Food Science and Nutrition*. 36(5):465-513.

Franks, F. (1982). Water activity as a measure of biological viability and quality control. *Cereal Foods World*. 27(9):403-407.

Franks, F. (1991). Water activity: a credible measure of food safety and quality? *Trends in Food Science and Technology*. March:68-72.

Hardman, T.M. (1988). *Water and Food Quality*. Elsevier Press, London.

Kress-Rogers, E. (1993). Food quality measurement. *Food Industry News*. September:23-26.

Levine, H. and L. Slade. (1991). *Water Relationships in Foods*. Plenum Press, New York.

Mannheim, C.H., J.X. Liu, and S.G. Gilbert. (1994). Control of water in foods during storage. *Journal of Food Engineering*. 22:509-532.

McMeekin, T.A. and T. Ross. (1996). Shelf life prediction: Status and future possibilities. *International Journal of Food Microbiology*. 33:65-83.

Nelson, K.A. and T.P. Labuza. (1994). Water activity and

food polymer science: Implications of state on arrhenius and WLF models in predicting shelf life. *Journal of Food Engineering*. 22:271-289.

Rockland, L.B. and G.F. Stewart. (1981). *Water Activity: Influences on Food Quality*. Academic Press, New York.

Rockland, L.B. and S.K. Nishi. (1980). Influence of water activity on food product quality and stability. *Food Technology*. 34:42-59.

Seow, C.C., T.T. Teng, and C.H. Quah. (1988). *Food Preservation by Moisture Control*. Elsevier, New York.

Taoukis, P., W. Breene, and T.P. Labuza. (1988). Intermediate moisture foods. *Advances in Cereal Science and Technology*. 9:91-128.

Water Activity and Microbiology

Beuchat, L.R. (1981). Microbial stability as affected by water activity. *Cereal Foods World*. 26(7):345-349.

Chen, H.C. (1995). Seafood microorganisms and seafood safety. *Journal of Food and Drug Analysis*. 3:133-144.

Farber, J.M., F. Coates, and E. Daley. (1992). Minimum water activity requirements for the growth of *Listeria monocytogenes*. *Letters In Applied Microbiology*. 15:103-105.

Garcia de Fernando, G.D., O. Diaz, M. Fernandez, and J.A. Ordonez. (1992). Changes in water activity of selected solid culture media throughout incubation. *Food Microbiology*. 9:77-82.

Gibson, A.M., J. Baranyi, J.I. Pitt, M.J. Eyles, and T.A. Roberts. (1994). Predicting fungal growth: The effect of water activity on *Aspergillus flavus* and related species. *International Journal of Food Microbiology*. 23:419-431.

Goalen, N., J.E. Smith, J. Lacey, and G. Gettinby. (1997). Effects of temperature, water activity, and incubation time on production of aflatoxins and cyclopiazonic acid by an isolate of *Aspergillus flavus* in surface agar culture. *Applied and Environmental Microbiology*. 63:1048-1053.

Hocking, A.D. and B.F. Miscamble. (1995). Water relations of some Zygomycetes isolated from food. *Mycological Research*. 99:1113-1118.

Hocking, A.D., B.F. Miscamble, and J.I. Pitt. (1994). Water relations of *Alternaria alternata*, *Cladosporium cladosporioides*, *Cladosporium sphaerospermum*, *Curvularia lunata* and *Curvularia pallescens*. *Mycological Research*. 98:91-94.

Houtsma, P.C., A. Heuvelink, J. Dufrenne, and S. Notermans. (1994). Effect of sodium lactate on toxin production, spore germination and heat resistance of proteolytic *Clostridium botulinum* strains. *Journal of Food Protection*. 57:327-330.

Kuntz, L.A. (1992). Keeping microorganisms in control. *Food Product Design*. August:44-51.

Li, K.Y. and J.A. Torres. (1993). Water activity relationships for selected mesophiles and psychrotrophs at refrigeration temperature. *Journal of Food Protection*. 56:612-615.

Marauska, M., A. Vigants, A. Klincare, D. Upite, E. Kaminska, and M. Bekers. (1996). Influence of water activity and medium osmolality on the growth and acid production of *Lactobacillus casei* var. *alactosus*. *Proceedings of the Latvian Academy of Sciences Section B Natural Exact and Applied Sciences*. 50:144-146.

Miller, A.J. (1992). Combined water activity and solute effects on growth and survival of *Listeria monocytogenes* Scott A. *Journal of Food Protection*. 55:414-418.

Nakajo, M. and Y. Moriyama. (1993). Effect of pH and water activity on heat resistance of spores of *Bacillus coagulans*. *Journal of the Japanese Society for Food Science and Technology*. 40:268-271.

Nolan, D.A., D.C. Chamblin, and J.A. Troller. (1992). Minimal water activity levels for growth and survival of *Listeria monocytogenes* and *Listeria innocua*. *International Journal of Food Microbiology*. 16:323-335.

Petersson, S. and J. Schnuerer. (1995). Biocontrol of mold growth in high-moisture wheat stored under airtight conditions by *Pichia anomala*, *Pichia guilliermondii*, and *Saccharomyces cerevisiae*. *Applied and Environmental Microbiology*. 61:1027-1032.

Pitt, J.I. and B.F. Miscalable. (1995). Water relations of *Aspergillus flavus* and closely related species. *Journal of Food Protection*. 58:86-90.

Quintavalla, S. and G. Parolari. (1993). Effects of temperature, a_w and pH on the growth of *Bacillus* cells and spore: A response surface methodology study. *International Journal of Food Microbiology*. 19:207-216.

Saad, R.R. (1992). Effect of water activity on growth and lipids of xerophilic fungi, *Aspergillus repens* and *Aspergillus amstelodami*. *Zentralblatt Fuer Mikrobiologie*. 147:61-64.

Santos, J., T.M. Lopez-Diaz, M.L. Garcia-Lopez, M.C. Garcia-Fernandez, and A. Otero. (1994). Minimum water activity for the growth of *Aeromonas hydrophila* as affected by strain, temperature and humectant. *Letters In Applied Microbiology*. 19:76-78.

Tapia de Daza, M.S., Y. Villegas, and A. Martinez. (1991). Minimal water activity for growth of *Listeria monocytogenes* as affected by solute and temperature. *International Journal of Food Microbiology*. 14:333-338.

Tokuoka, K. and T. Ishitani. (1991). Minimum water activities for the growth of yeasts isolated from high-sugar foods. *Journal of General and Applied Microbiology*. 37:111-119.

Ucar, F. and I. Guneri. (1996). The effect of water activity (a_w), pH and temperature on the growth of osmophilic yeasts. *Turkish Journal of Biology*. 20:37-46.

Wijtzes, T., P.J. McClure, M.H. Zwietering, and T.A. Roberts. (1993). Modelling bacterial growth of *Listeria monocytogenes* as a function of water activity, pH and temperature. *International Journal of Food Microbiology*. 18:139-149.

Zwietering, M.H., T. Wijtzes, J.C. De-Wit, and R.K. Van't. (1992). A decision support system for prediction of the microbial spoilage in foods. *Journal of Food Protection*. 55:973-979.

Water Activity in Foods

Meat and Seafood

Chen, N. and L.A. Shelef. (1992). Relationship between water activity, salts of lactic acid, and growth of *Listeria monocytogenes* in a meat model system. *Journal of Food Protection*. 55:574-578.

Clavero, M.R.S. and L.R. Beuchat. (1996). Survival of *Escherichia coli* O157:H7 in broth and processed salami as influenced by pH, water activity, and temperature and suitability of media for its recovery. *Applied and Environmental Microbiology*. 62:2735-2740.

Duffy, L.L., P.B. Vanderlinde, and F.H. Grau. (1994). Growth of *Listeria monocytogenes* on vacuum-packed cooked meats: Effects of pH, a_w , nitrite and ascorbate. *International Journal of Food Microbiology*. 23:377-390.

Fernandez-Salguero J., R. Gómez, and M.A. Carmona. (1994). Water activity of Spanish intermediate-moisture meat products. *Meat Science*. 38:341-346.

Gómez, R. and Fernandez-Salguero J. (1993). Note: Water activity of Spanish intermediate moisture fish products. *Revista Espanola De Ciencia Y Tecnologia De Alimentos*. 33:651-656.

Hand, L. (1994). Controlling water activity and pH in snack sticks. *Meat Marketing and Technology*. May:55-56.

Lee, M.B. and S. Styliadis. (1996). A survey of pH and water activity levels in processed salamis and sausages in Metro Toronto. *Journal of Food Protection*. 59:1007-1010.

Luecke, F.K. (1994). Fermented meat products. *Food Research International*. 27:299-307.

Minegishi, Y., Y. Tsukamasa, K. Miake, T. Shimasaki, C. Imai, M. Sugiyama, and H. Shinano. (1995). Water activity and microflora in commercial vacuum-packed smoked salmons. *Journal of the Food Hygienic Society of Japan*. 36:442-446.

Rocha-Garza, A.E. and J.F. Zayas. (1996). Quality of broiled beef patties supplemented with wheat germ protein flour. *Journal of Food Science*. 61:418-421.

Shimasaki, T., K. Miake, Y. Tsukamasa, M.A. Sugiyama, Y. Minegishi, and H. Shinano. (1994). Effect of Water Activity and Storage Temperature on the Quality and Microflora of Smoked Salmon. *Nippon Suisan Gakkaishi*. 60:569-576.

Untermann, F. and C. Muller. (1992). Influence of a_w value and storage temperature on the multiplication and enterotoxin formation of staphylococci in dry-cured raw hams. *International Journal of Food Microbiology*. 16:109-115.

Williams, S.K., G.E. Rodrick, and R.L. West. (1995). Sodium lactate affects shelf life and consumer acceptance of fresh (*Ictalurus nebulosus*, *marmoratus*) fillets under simulated retail conditions. *Journal of Food Science*. 60:636-639.

Dairy Products

Fresno, J.M., M.E. Tornadijo, J. Carballo, P.J. Gonzalez, and A. Bernardo. (1996). Characterization and biochemical changes during the ripening of a Spanish craft goat's milk cheese (Armada variety). *Food Chemistry*. 55:225-230.

Hong, Y.H. (1991). Physical and chemical properties of the process cheese on the domestic market. *Korean Journal of Animal Science*. 33:387-391.

Kombila, M.E. and C. Lacroix. (1991). The effect of combinations of salt, lactose and glycerol on the water activity (a_w) of cheese spreads. *Canadian Institute of Food Science and Technology Journal*. 24:233-238.

Pisecky, J. (1992). Water activity of milk powders. *Milchwissenschaft*. 47:3-7.

Tornadijo, E., J.M. Fresno, J. Carballo, and S.R. Martin. (1993). Study of Enterobacteriaceae throughout the manufacturing and ripening of hard goats' cheese. *Journal of Applied Bacteriology*. 75:240-246.

Valik, L. and F. Gorner. (1995). Effect of water activity adjusted with different solutes on growth and Lactic acid production by *Lactobacillus helveticus*. *Folia Microbiologica*. 40:472-474.

Vivier, D., M. Rivemale, J.P. Reverbel, R. Ratomahenina, and P. Galzy. (1994). Study of the growth of yeasts from feta cheese. *International Journal of Food Microbiology*. 22:207-215.

Vivier, D., R. Ratomahenina, and P. Galzy. (1994). Characteristics of micrococci from the surface of Roquefort cheese. *Journal of Applied Bacteriology*. 76:546-552.

Fruits and Vegetables

Ayub, M., R. Khan, S. Wahab, A. Zeb, and J. Muhammad. (1995). Effect of crystalline sweeteners on the water activity and shelf stability of osmotically dehydrated guava. *Sarhad Journal of Agriculture*. 11:755-761.

Beveridge, T. and S.E. Weintraub. (1995). Effect of blanching pretreatment on color and texture of apple slices at various water activities. *Food Research International*. 28:83-86.

Hubinger, M., F.C. Menegalli, R.J. Aguerre, and C. Suarez. (1992). Water vapor adsorption isotherms of guava, mango and pineapple. *Journal of Food Science*. 57:1405-1407.

Jimenez, M., M. Manez, and E. Hernandez. (1996). Influence of water activity and temperature on the production of zearalenone in corn by three *Fusarium* species. *International Journal of Food Microbiology*. 29:417-421.

Kiranoudis, C.T., Z.B. Maroulis, E. Tsami, and K.D. Marinou. (1993). Equilibrium moisture content and heat of desorption of some vegetables. *Journal of Food Engineering*. 20:55-74.

Makower, B. and G.L. Dehority. (1943). Equilibrium moisture content of dehydrated vegetables. *Industrial and Engineering Chemistry*. 35(2):193-197.

Maltini, E., D. Torreggiani, B.R. Brovotto, and G. Bertolo. (1993). Functional properties of reduced moisture fruits as ingredients in food systems. *Food Research International*. 26:413-419.

Marin, S., V. Sanchis, and N. Magan. (1995). Water activity, temperature, and pH effects on growth of *Fusarium moniliforme* and *Fusarium proliferatum* isolates from maize. *Canadian Journal of Microbiology*. 41:1063-1070.

Monsalve-Gonzalez, A., G.V. Barbosa-Canovas, and R.P. Cavalieri. (1993). Mass transfer and textural changes during processing of apples by combined methods. *Journal of Food Science*. 58:1118-1124.

Tapia de Daza, M.S., C.E. Aguilar, V. Roa, and R.V. Diaz de Tablante. (1995). Combined stress effects on growth of *Zygosaccharomyces rouxii* from an intermediate moisture papaya product. *Journal of Food Science*. 60:356-359.

Zeb, A., R. Khan, A. Khan, M. Saeed, and S.A. Manan. (1994). Influence of crystalline sucrose and chemical preservatives on the water activity and shelf stability of intermediate banana chips. *Sarhad Journal of Agriculture*. 10:721-726.

Zhang, X.W., X. Liu, D.X. Gu, W. Zhou, R.L. Wang, and P. Liu. (1996). Desorption isotherms of some vegetables. *Journal of the Science of Food and Agriculture*. 70:303-306.

Baked Goods and Cereals

Aramouni, F.M., K.K. Kone, J.A. Craig, and D.-Y.C. Fung. (1994). Growth of *Clostridium sporogenes* PA 3679 in home-style canned quick breads. *Journal of Food Protection*. 57:882-886.

Cahagnier, B., L. Lesage, and M.D. Richard. (1993). Mould growth and conidiation in cereal grains as affected by water activity and temperature. *Letters In Applied Microbiology*. 17:7-13.

Clawson, A.R. and A.J. Taylor. (1993). Chemical changes during cooking of wheat. *Food Chemistry*. 47:337-343.

Gómez, R., Fernandez-Salguero J., M.A. Carmona, and D. Sanchez. (1993). Water activity in foods with intermediate moisture levels: Bakery and confectionery products: Miscellany. *Alimentaria*. 30:55-57.

Harris, M. and M. Peleg. (1996). Patterns of textural changes in brittle cellular cereal foods caused by moisture sorption. *Cereal Chemistry*. 73:225-231.

Michniewicz, J., C.G. Biliaderis, and W. Bushuk. (1992). Effect of added pentosans on some properties of wheat bread. *Food Chemistry*. 43:251-257.

Ramanathan, S. and S. Cenkowski. (1995). Sorption isotherms of flour and flow behaviour of dough as influenced by flour compaction. *Canadian Agricultural Engineering*. 37:119-124.

Roessler, P.F. and M.C. Ballenger. (1996). Contamination of an unpreserved semisoft baked cookie with a xerophilic *Aspergillus* species. *Journal of Food Protection*. 59:1055-1060.

Seiler, D.A.L. (1979). The mould-free shelf life of bakery products. *FMBRA Bulletin*. April(2):71-74.

Sumner, S.S., J.A. Albrecht, and D.L. Peters. (1993). Occurrence of enterotoxigenic strains of *Staphylococcus aureus* and enterotoxin production in bakery products. *Journal of Food Protection*. 56:722-724.

Tesch, R., M.D. Normand, and M. Peleg. (1996). Comparison of the acoustic and mechanical signatures of two cellu-

lar crunchy cereal foods at various water activity levels. *Journal of the Science of Food and Agriculture*. 70:347-354.

Weegels, P.L., J.A. Verhoek, A.M.G. de Groot, and R.J. Hamer. (1994). Effects of gluten of heating at different moisture contents: I. Changes in functional properties. *Journal of Cereal Science*. 19:31-38.

Beverages/Soups/Sauces/Preserves

Carson, K.J., J.L. Collins, and M.P. Penfield. (1994). Unrefined, dried apple pomace as a potential food ingredient. *Journal of Food Science*. 59:1213-1215.

Durrani, M.J., R. Khan, M. Saeed, and A. Khan. (1992). Development of concentrated beverages from Anna apples with or without added preservatives by controlling activity of water for shelf stability. *Sarhad Journal of Agriculture*. 8:23-28.

Ferragut, V., J.A. Salazar, and A. Chiralt. (1993). Stability in the conservation of emulsified sauces low in oil content. *Alimentaria*. 30:67-69.

Ibarz, A., J. Pagan, and R. Miguelsanz. (1992). Rheology of clarified fruit juices: II. Blackcurrant juices. *Journal of Food Engineering*. 15:63-74.

AquaLab

13. Further Reading

Kusumegi, K., T. Takahashi, and M. Miyagi. (1996). Effects of addition of sodium citrate on the pasteurizing conditions in “Tuyu”, Japanese noodle soup. *Journal of the Japanese Society for Food Science and Technology*. 43:740-747.

Sa, M.M. and A.M. Sereno. (1993). Effect of temperature on sorption isotherms and heats of sorption of quince jam. *International Journal of Food Science and Technology*. 28:241-248.

Pharmaceuticals/Cosmetics

Ahlneck, C. and G. Zografi. (1990). The molecular basis of moisture effects on the physical and chemical stability of drugs in the solid state. *International Journal of Pharmaceutics*. 62:87-95.

Cochet, N. and A.L. Demain. (1996). Effect of water activity on production of beta-lactam antibiotics by *Streptomyces clavuligerus* in submerged culture. *Journal of Applied Bacteriology*. 80:333-337.

Costantino, H.R., R. Langer, and A.M. Klibanov. (1994). Solid-phase aggregation of proteins under pharmaceutically relevant conditions. *Journal of Pharmaceutical Sciences*. 83:1662-1669.

Enigl, D.C. and K.M. Sorrels. (1997). Water Activity and Self-Preserving Formulas. In: Preservative-Free and Self-Preserving Cosmetics and Drugs: Principles and Practice. Kabara, J.J. and D.S. Orth (ed.) Marcel Dekker, pp. 45-73.

Hageman, M.J. (1988). The role of moisture in protein stability. *Drug Development and Industrial Pharmacy*. 14(14):2047-2070.

Heidemann, D.R. and P.J. Jarosz. (1991). Formulation studies involving moisture uptake in solid dosage forms. *Pharmaceutical Research*. 8(3):292-297.

Friedel, R.R. and A.M. Cundell. (1998). The application of water activity measurement to the microbiological attributes testing of nonsterile over-the-counter drug products. *Pharmaceutical Forum*. 24(2):6087-6090.

Kontny, M.J. (1988). Distribution of water in solid pharmaceutical systems. *Drug Development and Industrial Pharmacy*. 14(14):1991-2027.

Zografí, G. (1988). States of water associated with solids. *Drug Development and Industrial Pharmacy*. 14(14):1905-1926.

Zografí, G. and M.J. Kontny. (1986). The interactions of water with cellulose- and starch-derived pharmaceutical excipients. *Pharmaceutical Research*. 3(4):187-193.

Miscellaneous

Bell, L.N. and T.P. Labuza. (1992). Compositional influence on the pH of reduced-moisture solutions. *Journal of Food Science*. 57:732-734.

Bell, L.N. and T.P. Labuza. (1994). Influence of the low-moisture state on pH and its implication for reaction kinetics. *Journal of Food Engineering*. 22:291-312.

Bell, L.N. (1995). Kinetics of non-enzymatic browning in amorphous solid systems: Distinguishing the effects of water activity and the glass transition. *Food Research International*. 28:591-597.

Brake, N.C. and O.R. Fennema. (1993). Edible coatings to inhibit lipid migration in a confectionery product. *Journal of Food Science*. 58:1422-1425.

Dole, M. and L. Faller. (1950). Water sorption by synthetic high polymers. *Journal of the American Chemical Society*. 72:414-419.

Fernandez-Salguero J., R. Gómez, and M.A. Carmona. (1993). Water activity in selected high-moisture foods. *Journal of Food Composition and Analysis*. 6:364-369.

Lomauro, C.J., A.S. Bakshi, and T.P. Labuza. (1985). Evaluation of food moisture sorption isotherm equations. Part I: Fruit, vegetable and meat products. *Lebensmittel-Wis-*

senschaft und-Technologie. 18:111-117.

Lomauro, C.J., A.S. Bakshi, and T.P. Labuza. (1985). Evaluation of food moisture sorption isotherm equations. Part II: Milk, coffee, tea, nuts, oilseeds, spices and starchy foods. *Lebensmittel-Wissenschaft und-Technologie*. 18:118-124.

Yasuda, H., H.G. Olf, B. Crist, C.E. Lamaze, and A. Peterlin. (1972). Movement of water in homogeneous water-swollen polymers. In: *Water Structure at the Water Polymer Interface*. Jellinek, H.H.G. (ed.) Plenum Press, New York/London.

Appendix A

Preparing Salt Solution

If you choose to mix a saturated salt solution for use as a calibration standard, we recommend that you use the approved AOAC method. This method is as follows:

1. Select a reagent-grade salt and place it in a test container to a depth of about 4cm for more soluble salts (lower water activity), to a depth of about 1.5 cm for less soluble salts (high water activity), and to an intermediate depth for intermediate salts.
2. Add distilled water in increments of about 2mL, stirring constantly.
3. Add water until the salt can absorb no more water, evidenced by the presence of free liquid. Keep the amount of free liquid to the minimum needed to keep the solution saturated with water. If you plan on using this solution over a long term period, seal the solution well to prevent losses from evaporation. Below is a table of saturated salt solutions and their respective water activities at various temperatures. Please note that these values are based on averaged published data, and the standard errors shown reflect Greenspan's

standard error for each salt solution, not the AquaLab's accuracy in measuring the salt. AquaLab measures all samples with an accuracy of $\pm 0.003a_w$.

4. Saturated salt solutions are very temperature-sensitive and their values are not as accurate as the calibration standards offered by Decagon.

Table 1: Water Activity of Selected Salt Solutions

Saturated Solution	a_w at 20° C	a_w at 25° C
Lithium Chloride	0.113 ± 0.003	0.113 ± 0.003
Magnesium Chloride	0.331 ± 0.002	0.328 ± 0.002
Potassium Carbonate	0.432 ± 0.003	0.432 ± 0.004
Magnesium Nitrate	0.544 ± 0.002	0.529 ± 0.002
Sodium Chloride	0.755 ± 0.001	0.753 ± 0.001
Potassium Chloride	0.851 ± 0.003	0.843 ± 0.003
Potassium Sulfate	0.976 ± 0.005	0.973 ± 0.005

Adapted from Greenspan (1977). Rounded to nearest thousandth.

Appendix B

Table 2: Temperature Correction of Decagon's Calibration Standards

Temp. (°C)	H ₂ O	0.5m KCl	6.0m NaCl	8.57m LiCl	13.41m LiCl
15.0	1.000	0.984	0.761	0.492	0.238
20.0	1.000	0.984	0.760	0.496	0.245
25.0	1.000	0.984	0.760	0.500	0.250
30.0	1.000	0.984	0.760	0.504	0.255
35.0	1.000	0.984	0.760	0.508	0.261
40.0	1.000	0.984	0.760	0.512	0.266

Aqualab will measure these standards to $\pm 0.003a_w$

Declaration of Conformity

Application of Council Directive:	89/336/EEC
Standards to which conformity is declared:	EN81-1 EN500082-1
Manufacturer's Name:	Decagon Devices, Inc. 2365 NE Hopkins Court Pullman, WA 99163 USA
Type of Equipment:	AquaLab water activity meter.
Model Number:	Series 3
Year of First Manufacture:	1999

This is to certify that the AquaLab water activity meter, manufactured by Decagon Devices, Inc., a corporation based in Pullman, Washington, USA meets or exceeds the standards for CE compliance as per the Council Directives noted above. All instruments are built at the factory at Decagon and pertinent testing documentation is freely available for verification. This certification applies to all AquaLab Series 3 models, including, but not limited to, the Series 3 and 3TE.

Certificate of Traceability

Decagon Devices, Inc.
2365 NE Hopkins Court
Pullman WA 99163
tel: (509) 332-2756
fax: (509) 332-5158
support@decagon.com

This is to certify that AquaLab water activity meters are manufactured utilizing temperature standards with calibration traceable to the National Institute of Standards and Technology (NIST).

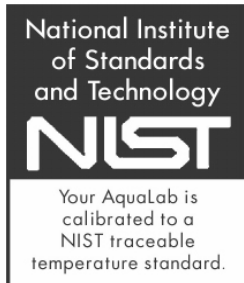

Index

A

Accessories 17

Accuracy 4

AquaLab

and chilled mirror dewpoint technique 5

and temperature 6

limitations of 8

theory 9

B

Beeper 25

changing

Block failure 61

Buttons

for linear offset settings 37

for menu selection 21

C

C for continuous mode 23

Calibration 35

Calibration standards 33

Cautions 49

CE compliance 93

Chilled-mirror technique 5

Cleaning 27

Coated samples

shortening read time for 43

Component performance indicator 62

Components 17

Computer interface 52

AquaLab

Index

Continuous sampling mode 23

Customer service 1

Czech 21

D

Danish 21

Declaration of Conformity 93

Dehydrated samples 44

Dried samples 43

Dry samples 50, 58, 59

E

Error messages 54

 "sample too dry" 58, 59

 "sample too hot" 58

 triangle on screen 60

Exit 26

F

Fan

 inside sample chamber 6

Features 18

Flashing. See LED

French 21

Further reading 67

Fuse, changing of 55

G

German 21

H

Hyperterminal

 using for downloading 53

I

Italian 21

L

Languages

changing 21

LED 25

Linear offset

causes for 33

definition 33

how to adjust for 35

menu 26

when to verify for 35

Location

for sampling 18

Low water activity 46, 50

M

Main menu 19, 21

Maintenance 27

Manual 1

Material Safety Data Sheet 34

Menus

main menu 21

system configuration 24

N

NIST

traceability 94

Norwegian 21

O

Osmotic effects 13

AquaLab

Index

P

Peltier cooler 6

Portuguese 21

Preparing salt solutions 90

Propylene glycol 46, 56
cleaning out of chamber 46

R

Read time

affected by sample temp. 46
long read time 6, 43, 56

Readings

cautions 49
how AquaLab takes 48, 49
taking readings 48

References 67

Relative humidity 5, 11

Repair

instructions for 64

S

Salt standards. See calibration standards

Sample

slow water-emitting 56

Sample cups

cleaning 42
filling level 42

Sample equilibration screen 7

Sample preparation 41

Sample too dry 51, 58, 59

Sample too hot 47, 50

Samples

coated 43

- dehydrated 44
- dried 43
- low water activity 46
- multi-component 41
- needing special preparation 43
- not at room temperature 46
- slow water-emitting 44
- surface area of 44
- viscous 44

Sampling modes

- continuous 23
- normal 21

Saturated salts 90

Seller's liability 3

Spanish 21

Spilling the sample 49

Swedish 21

T

Technical support 1

Temperature

- effects on water activity 11
- hot samples 50
- of instrument 50
- samples not at room temp. 46

Temperature control 6

- reasons for 7

Theory

- water activity 67

Time

- long read times 56

Triangle

- mirror performance indicator 60

Troubleshooting 54**V****Verification 35****Verification standards 33**

aw readings too high/low for 57

compared to saturated salts 91

Volatiles 8, 46**W****Warm-up 20****Warranty 2****Water activity**

adjusting for offset 39

Aqualab and 4

calibration standards 34

definition 5, 9

displayed 19

effect on food 5, 9

low 50, 51

stability diagram 10

theory 9

Water content

definition 9

vs. water activity 9

Water potential

factors in determining 13

matric effects 14

osmotic effects 13

relation to water activity 12